

P/N: FAPES301089

Outline Dimensions (Unit:mm)

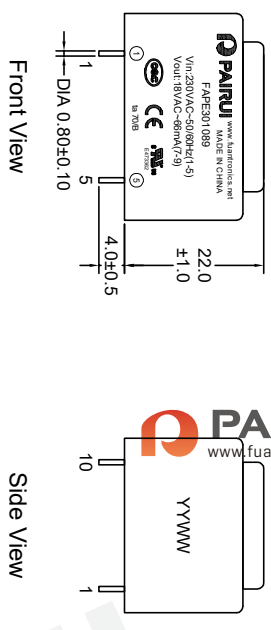

Electrical Schematic

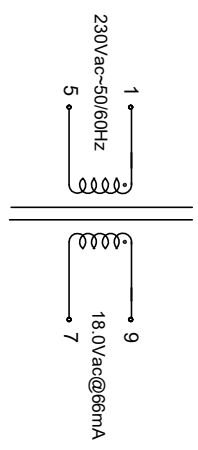

Electrical Characteristics

Input 230Vac 50Hz to 1-5 :
 Excitation current(Ix): 12.0mA Max.
 Output: Vo7-9=25.7Vac Typ(No-load).
 VL7-9=18.0Vac±5%(@66mA).
 Hi-Pot: Pri-Sec:4000VAC/5mA/60Second.

General Properties

Operating Temperature: -25°C to +70°C.
 Storage Temperature: -25°C to +85°C.
 Insulation Class: B.

Wave Soldering

Note:
 1.Remove Pins 2,3,4,6,8,10.

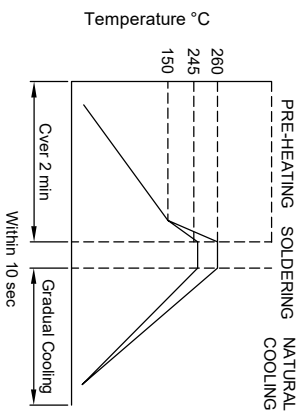

Note:
 1.Never Contact the ceramic with the iron tip:
 2. 1.0mm tip diameter(max).

REV	DESCRIPTION	APPD	DATE	Tianchang Fuan Electronic Co Ltd www.fuantronics.net TEL: +86-550-7814888 FAX: +86-550-7831133		Tolerances unless otherwise specified: (X)±0.50 (XX)±0.25 Unit of measurement: mm	Make: Qiumei Liu Checked: Beson. zhan Approved: Anson. zhan	DRAWING TITLE 1.20V Encapsulated Transformer For E130*10.5,230VAC Input 50/60Hz Material Number: A223010XS400	Customer Name: Document/Rev: 00 Specification Sheet: 1 of 3 Date of Recognition: Jan./02/2020
-----	-------------	------	------	---	--	---	---	---	--

P/N: FAPE301089

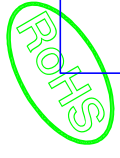

PAIRUI
www.fuantronics.net

List of UL Certificate:

No.	Part Name	Mat'l Description	Supplier	UL Number
1	Bobbin	EI30*10.5/PBT(Black)	Chang Chun Plastics Co Ltd	E59481
2	Case	CASE-EI30*10.5/PA66(Orange)	Zhejiang Juner New Materials Co Ltd	E204321
3	Copper wire	2UEW-H/180C	Elektrisla Hangzhou Co Ltd	E258243
4	Core	Lamination	Ta Yea Steel Industry Co Ltd	N/A
5	Epoxy	PU552(Black)	Wevo-Chemie Gmbh	E108835
6				

Packaging Specification:

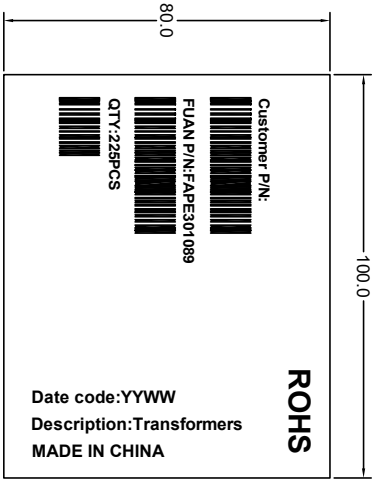

Laber of outer

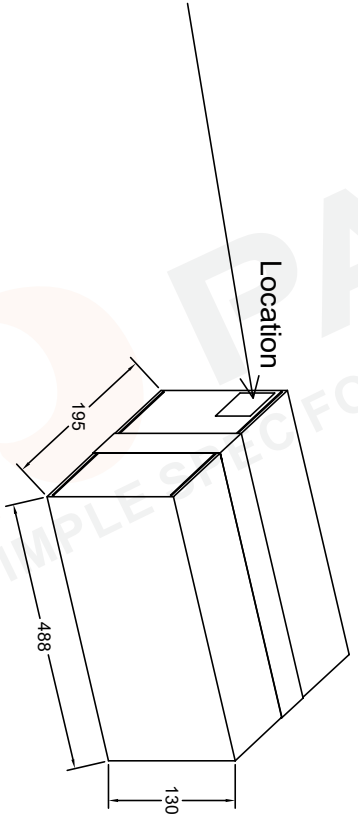

put the label on the top left corner of one of the carton sides

REV	DESCRIPTION	APPD	DATE	Tianchang Fuan Electronic Co Ltd www.fuantronics.net TEL: +86-550-7814888 FAX:+86-550-7831133		Make: Qiumei Liu Checked: Beason. zhan Approved: Anson. zhan	DRAWING TITLE 1.20V Encapsulated Transformer For EI30*10.5,230VAC Input 50/60Hz Material Number: A223010XSA400	Customer Name: Document/Rev: 00 Specification Sheet: 2 of 3 Date of Recognition: Jan./02/2020
-----	-------------	------	------	--	--	--	--	--

P/N: FAPE301089

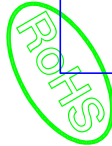

Packing Method:

Soft Rubber
Stopper



Product

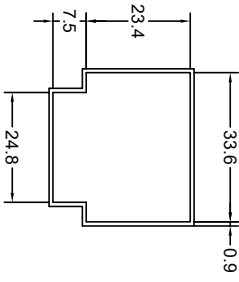
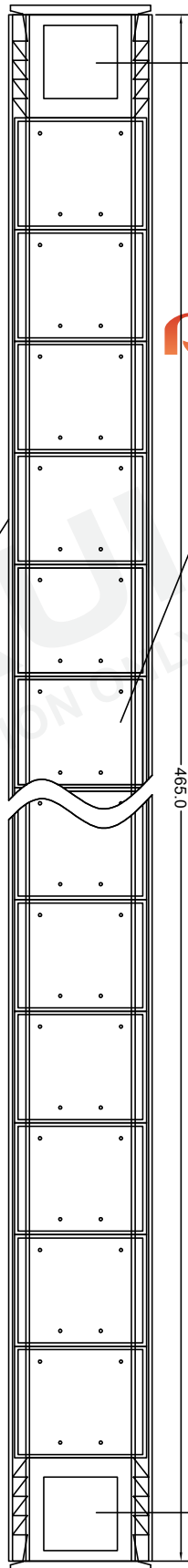

Size of packaging tube:
465mm*35.4mm*32.7mm
(Length * Width * Height)

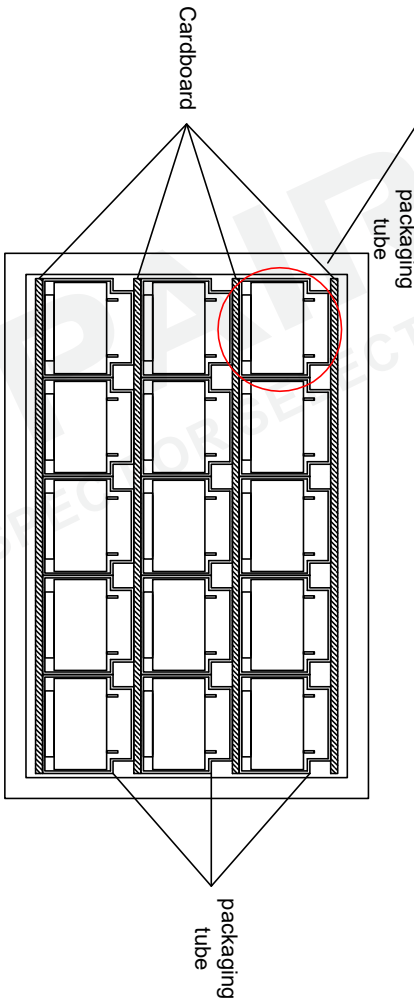

Layer/Carton	Quantity/Tube (pcs)	Quantity/Carton (pcs)	Net weight (g/pc)	Gross weight (g/tube)	Tubes/carton (pcs)	Total weight (kg)	box size Dimensions (mm)
3.0	15.0	225.0	70.0	94.56	15.00	17.80	488*195*130

REV	DESCRIPTION	APPD	DATE	<p>Tianchang Fuan Electronic Co Ltd www.fuantronics.net TEL: +86-550-7814888 FAX: +86-550-7831133</p>		<p>Make: Qiumei Liu Checked: Beason. zhan Approved: Anson. zhan</p>		<p>DRAWING TITLE 1.20V Encapsulated Transformer For E130*10.5,230VAC Input 50/60Hz Material Number: A223010XS400</p>		<p>Customer Name: Document/Rev: 00 Specification Sheet: 3 of 3 Date of Recognition: Jan./02/2020</p>	
-----	-------------	------	------	---	--	---	--	---	--	--	--

6 5 4 3 2 1 A B C D E F